

Manual of Operation and Instruction

Model 3660 CoreReader™



Troxler Electronic Laboratories, Inc.

P.O. Box 12057 • 3008 Cornwallis Road

Research Triangle Park, NC 27709

Phone: (919) 549-8661 • Fax (919) 549-0761

www.troxlerlabs.com

**Troxler products are protected by U.S. and foreign patents.
The Model 3660 CoreReader™ is protected by
U.S. Patent US 6,492,641 B1.**

Copyright © 2003

**Troxler Electronic Laboratories, Inc.
All Rights Reserved**

No part of this manual may be reproduced or transmitted in any form or by any means, electronic or mechanical, including photocopying, recording, or information storage and retrieval systems, for any purpose without the express written permission of Troxler Electronic Laboratories, Inc.

CoreReader is a trademark of Troxler Electronic Laboratories, Inc.

PN 109707
November 2003
Edition 1.0



SAFETY ALERT SYMBOL



The Safety Alert Symbol shall appear within this manual. Wherever it appears in this manual or on safety signs affixed to the machine, this is to make all aware of the potential for personal injury and to be cautious when these images are present.

Always observe all WARNING, CAUTION, and NOTE recommendations listed within this manual before operating the machine.



TROXLER SERVICE CENTERS

Troxler Corporate Headquarters

3008 Cornwallis Road
P.O. Box 12057
Research Triangle Park, NC 27709
Tel (919) 549-8661
Fax (919) 549-0761
E-mail: troxserv@troxlerlabs.com
Web: www.troxlerlabs.com

Maryland Service Center

9574 Deereco Road
Timonium, MD 21093
Tel (410) 561-5850
Fax (410) 561-5852
E-mail: troxlermd@troxlerlabs.com

Midwestern Branch Office

1430 Brook Drive
Downers Grove, IL 60515
Tel (630) 261-9304
Fax (630) 261-9341
E-mail: troxmidw@troxlerlabs.com

Western Regional Branch Office

11300 Sanders Drive, Suite 7
Rancho Cordova, CA 95742
Tel (916) 631-0234
Fax (916) 631-0541
E-mail: troxca@troxlerlabs.com

Southwestern Branch Office

2000 East Randol Mill Road
Suite 611
Arlington, TX 76011
Tel (817) 275-0571
Fax (817) 275-8562
E-mail: troxsw@troxlerlabs.com

Florida Service Center

2376 Forsyth Road
Orlando, FL 32807
Tel (407) 681-4221
Fax (407) 681-3188
E-mail: troxlerfl@troxlerlabs.com

Colorado Service Center

702 West 48th Avenue, Unit G
Denver, CO 80216
Tel: (303) 298-0751
Fax: (303) 298-0778
E-mail: troxlerco@troxlerlabs.com

Canadian Branch Office

7125 Pacific Circle, Unit 13
Mississauga, Ontario L5T-2A5
Canada
Tel (905) 565-0633
Fax (905) 564-7092
E-mail: troxler@istar.ca

Troxler European Subsidiary

Troxler Electronics GmbH
Gilchinger Strasse 33
D-82239 Alling nr. Munich, Germany
Tel ++49-8141-71063
Fax ++49-8141-80731
E-mail: troxler@t-online.de

HOW TO USE THIS MANUAL

Congratulations on the purchase of the **Model 3660 CoreReader™**.

The *Model 3660 Manual of Operation and Instruction* contains instructions for the safe operation of this unit. Also included in this manual are safety warnings as well as information concerning parameter setup, calibration, system troubleshooting, and general maintenance.

Do not attempt to operate the CoreReader before reading this manual and the safety warnings posted on the unit. Troxler stresses that *the user is solely responsible* for ensuring the safe use of the CoreReader. Neither the manufacturer, its subsidiary, representatives, or distributors can assume responsibility for any mishaps, damage, or personal injury that may occur from failure to observe the safety warnings in this manual and posted on the unit.

CONVENTIONS USED IN THIS MANUAL

Throughout this manual, symbols and special formatting are used to reveal the purpose of the text as follows:

WARNING

Indicates conditions or procedures that, if not followed correctly, may cause personal injury.

CAUTION

Indicates conditions or procedures that, if not followed correctly, may cause equipment damage.

NOTE

Indicates important information that must be read to ensure proper operation.

⟨KEY⟩ Angle brackets and a different typestyle indicate a key or character (number or letter) to press on the CoreReader keypad. For example, “Press ⟨START⟩” means to press the key labeled *START*.

DISPLAY A different typestyle is used in text to indicate information or messages displayed by the CoreReader.

DISPLAY - Typestyle
and shading used to
simulate CoreReader
display

- ◆ Diamonds indicate a list of things needed (such as equipment) or things to know.
- ✓ Check marks indicate the performance of an action. With lists of check marks, follow the instructions in the order of the check marks.
- ▶ Triangles indicate that more than one option is available. Carefully select the option that applies.

EU DECLARATION OF CONFORMITY

Application of Council EMC Directive 89/336/EEC, 93/42/EEC,
and Low Voltage Directive 73/23/EEC – as amended by
93/68/EEC.

Standards to which Conformity is Declared:

EN 61010–1+A2
EN 61326–1:1998

Manufacturer:

Troxler Electronic Laboratories, Inc.
P.O. Box 12057
3008 Cornwallis Road
Research Triangle Park, North Carolina
27709
U.S.A.

Apparatus:

Model 3660 CoreReader

Year of Manufacture:

2003

TABLE OF CONTENTS

CHAPTER 1. INTRODUCTION TO THE COREREADER

Introduction.....	1-2
Unpacking and Inspecting	1-4

CHAPTER 2. PRODUCT SAFETY INFORMATION

Radiological Information.....	2-2
Other Considerations	2-3
Disposal	2-4
Transportation.....	2-5
Cautions and Warnings.....	2-7
Safety Warnings.....	2-8

CHAPTER 3. SETUP AND OPERATION

Keypad.....	3-2
Site Selection	3-4
Installation	3-5
Turning the CoreReader On.....	3-6
First Time Setup.....	3-7
Taking a Measurement.....	3-8

CHAPTER 4. SETUP MENU

Setup Menu	4-3
Gauge Status	4-4
Sample Type	4-5
Standard	4-6
Clock/Calendar	4-9
Projects	4-12
Calibration	4-24
Confirmation.....	4-24
PC Output	4-25
Beeper	4-26

TABLE OF CONTENTS (Continued)

CHAPTER 5. CALIBRATION AND CONFIRMATION

Calibration.....	5-2
Model 3660 CoreReader.....	vii

Confirmation5-9

APPENDIX A. TROUBLESHOOTING AND SERVICE

Troubleshooting.....A-2
General Maintenance.....A-3
Replacing Parts.....A-4
Replacement PartsA-6
Returning Parts for Service.....A-7
Troxler Service CentersA-8

APPENDIX B. SPECIFICATIONS

Measurement Specifications.....B-2
Environmental Conditions.....B-3
Electrical SpecificationsB-4
Mechanical Specifications.....B-5

APPENDIX C. LOG FORMS

Standard Count LogsC-2
Calibration Constants LogsC-8

INDEX

WARRANTY

LIST OF FIGURES

<u>Figure</u>	<u>Title</u>	<u>Page</u>
1-1	Model 3660 CoreReader	1-3
3-1	CoreReader Keypad and Display	3-2
3-2	Measuring Height of a Core Sample	3-9
5-1	Calibration Standard Cylinders	5-3

LIST OF TABLES

<u>Table</u>	<u>Title</u>	<u>Page</u>
3-1	Keypad Functions.....	3-3
5-1	Cylinder Configurations, 150-mm Lab Calibration.....	5-5
5-2	Cylinder Configurations, 150-mm Field Calibration.....	5-6
5-3	Cylinder Configurations, 100-mm Calibration.....	5-7
5-4	Cylinder Configurations, 150-mm Lab Confirmation	5-10
5-5	Confirmation Acceptance Limits	5-12
5-6	Cylinder Configurations, 150-mm Field Confirmation	5-12
5-7	Cylinder Configurations, 100-mm Confirmation	5-15
A-1	Error Codes	A-2
B-1	CoreReader Precision and Count Times.....	B-2

NOTES

ATTENTION COREREADER OWNER

*This unit contains functions that require an ACCESS CODE.
This code must be entered before these functions may be used.*

The ACCESS CODE for the CoreReader is:

4819

This page should be removed if the access code is not to be distributed to other parties or users of this equipment.

NOTES

CHAPTER 1

INTRODUCTION TO THE COREREADER

This chapter provides a brief overview of the Troxler Model 3660 CoreReader™. The CoreReader measures the bulk specific gravity (G_{mb}) and density of a cylindrical hot-mix asphalt specimen. The CoreReader can accommodate specimens prepared using a gyratory compactor (such as Troxler's Model 4140 or 4141 Gyratory Compactor), Marshall samples, or specimens taken from a pavement core. The CoreReader is designed as a bench-top laboratory test instrument.

CONTENTS

Introduction.....	1-2
Unpacking and Inspecting	1-4

INTRODUCTION

The Model 3660 CoreReader (see Figure 1–1) measures the bulk specific gravity of laboratory-compacted or field core specimens without a water bath, paraffin, para-film, or any other sealer. The CoreReader uses a nondestructive gamma ray transmission method of measuring the specific gravity and density of a hot-mix asphalt specimen. This method is based on the scattering and absorption properties of gamma rays with matter. This gamma-ray method does *not* require any special sample preparation such as wrapping the sample with para-film, nor does it require a precision weighing scale and temperature-regulated water bath.

The CoreReader is equipped with a *sample tray* (see Figure 1–1) that can accommodate both 100-mm (4-inch) and 150-mm (6-inch) diameter cylindrical samples. The asphalt sample is placed on the sample tray, and is slid into the sample chamber between a gamma-ray source and a gamma-ray detector. The number of gamma rays that penetrate the sample and reach the detector is inversely proportional to the density of the material. The CoreReader converts the gamma-ray count to the bulk specific gravity of the sample.

To use the CoreReader, the operator first measures the height of the sample using a vernier caliper then places the sample into the unit. At the beginning of a measurement, the operator enters the height value into the unit via the front panel *keypad* (see Figure 1–1). The CoreReader measures the density of the sample and presents the results on the front panel *display*.

Although the CoreReader is calibrated at the factory, it must be calibrated at the user site before use. For on-site confirmation and calibration, eight standard cylinders of known bulk specific gravities, diameters, and heights are provided.

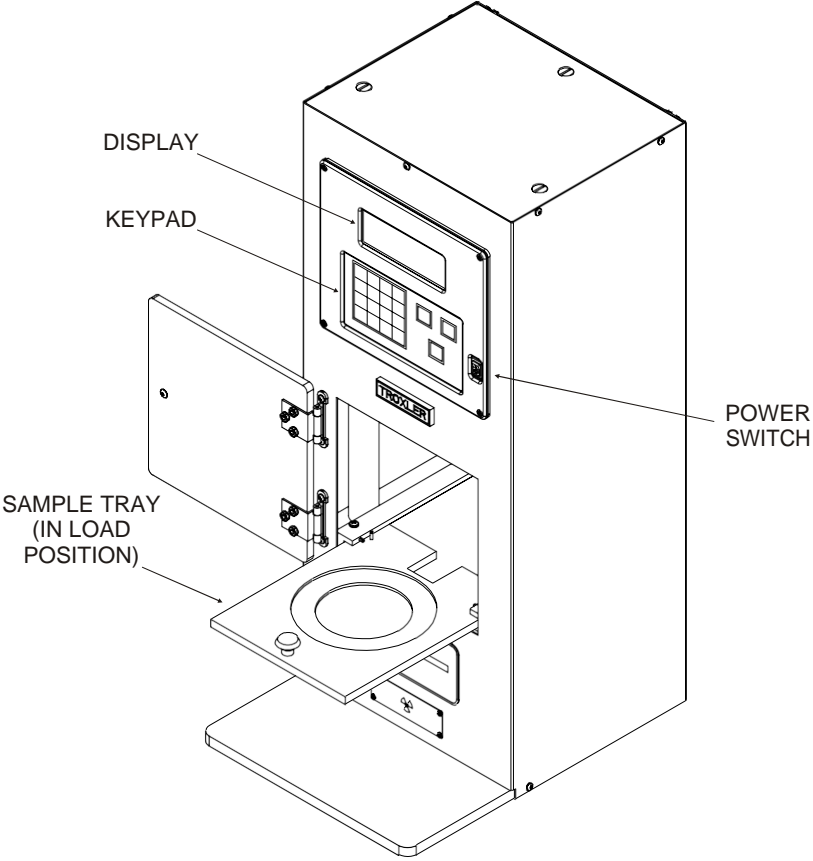

Figure 1-1. Model 3660 CoreReader

UNPACKING AND INSPECTING

NOTE

To ensure the safe return of the CoreReader to Troxler for repair or maintenance, please keep the original shipping boxes and all packing materials.

Upon receiving the CoreReader from the factory:

1. Perform a complete inspection and inventory. If the shipping case and/or any other part or accessory appears damaged, notify the carrier and your Troxler representative **immediately**.

NOTE

The carton containing the CoreReader should remain closed for 24 hours after the unit is received to allow the internal temperature to reach equilibrium.

NOTE

The calibration cylinders are packed in a separate carton.

2. Open the outer carton. Open the inner carton and carefully remove the CoreReader assembly. Save all packing material for reuse if the CoreReader needs to be returned for service or repair.
3. Check the shipping case for the following items:
 - ◆ CoreReader assembly
 - ◆ Eight calibration cylinders, labeled 150-1 through 150-4 and 100-1 through 100-4, packed in a carrying case
 - ◆ AC adapter, 12 V dc, CE international (PN 108354)
 - ◆ Serial cable, 8 ft (PN 106514)
 - ◆ Model 3660 CoreReader *Manual of Operation and Instruction* (PN 109707)
4. Inspect the outside surfaces of the CoreReader and accessories for damage.

CHAPTER 2

PRODUCT SAFETY INFORMATION

This chapter provides basic product safety information concerning the Model 3660 CoreReader, as well as cautions and warnings related to the safe use of the unit.

CONTENTS

Radiological Information.....	2-2
Other Considerations	2-3
Disposal	2-4
Transportation.....	2-5
Markings	2-5
Air Eligibility (Effective January 1, 2004).....	2-5
Waybill.....	2-6
Packaging	2-6
Cautions and Warnings.....	2-7
Safety Warnings.....	2-8

RADIOLOGICAL INFORMATION

The CoreReader contains 2.96 MBq (80 μ Ci) of cesium-137 (Cs-137) in the form of sealed sources. The sources are located in a source holder below the sample chamber, which provides protection against release of radioactivity under normal use and likely accident conditions, including fire. The sources are inaccessible to device operators.

WARNING

Do not attempt to disassemble or remove the radioactive sources from this device.

The radiation levels near the CoreReader are very low. Therefore, no special radiological precautions are necessary for operation of the device:

- ◆ Operators do not require radiation training or experience.
- ◆ Personnel radiation monitoring is not required.
- ◆ Sealed source leak testing is not required.
- ◆ Radiation area posting is not required.

The maximum radiation levels in or near the CoreReader are shown in the table below:

Location	Dose Rate	
	mrem/h	μ Sv/h
External surface	0.2	2
Distance of 30 cm	0.05	0.5
Inside sample chamber	1.5	15

The receipt, possession, use, and transfer of the CoreReader are exempt from licensing by the U.S. Nuclear Regulatory Commission (NRC) or Agreement States.

OTHER CONSIDERATIONS

The CoreReader uses low-level gamma-ray sources and a highly efficient gamma-ray detector. However, the operator must ensure that there are no other nuclear sources in the vicinity of this equipment. An excess of background radiation from a nearby source may affect the accuracy of the bulk specific gravity reading. The presence of another source may cause:

- ◆ The standard count to be higher than usual. For more information on the standard count, see page 4–6.
- ◆ The bulk specific gravity reading for a known sample to be lower than expected.

DISPOSAL

The CoreReader contains several small radioactive sources. It is recommended that users return the device to Troxler at the end of its useful life for removal and disposal of the radioactive sources in the most environmentally responsible manner. Please contact Troxler for further information.

TRANSPORTATION

Since the CoreReader contains a small quantity of radioactive material in the form of sealed sources, it must be prepared for shipment in accordance with applicable rules and regulations governing hazardous materials. These include:

- ◆ IATA's *Dangerous Goods Regulations*
- ◆ U.S. DOT's Hazardous Material Regulations (49 CFR Parts 100 to 185)
- ◆ Canada's *Packaging and Transport of Nuclear Substances Regulations* and *Transportation of Dangerous Goods (TGD) Regulations*

Because of amount of radioactivity and radiation levels are very low, the CoreReader meets the criteria for transport as an *excepted package* under all of the above regulations. Excepted packages must meet the following requirements:

MARKINGS

The package must be marked as follows:

- ◆ Proper shipping name – **Radioactive material, excepted package, instruments**
- ◆ UN ID number – **UN 2911**
- ◆ Full name and address of shipper and consignee
- ◆ Permissible gross weight of package if this exceeds 50 kg.

AIR ELIGIBILITY (EFFECTIVE JANUARY 1, 2004)

If offered for air transport, the package must have the air eligibility marking (IATA 10.7.1.6) placed next to the proper shipping name and UN ID.

WAYBILL

The waybill must state “Radioactive material, excepted package, instruments, UN 2911” in the *Nature and Quantity of Goods* box. A Dangerous Goods Declaration is not required for air transport.

PACKAGING

No special design, testing, or certification of the package is required. The package must meet general packaging requirements and must be capable of withstanding the conditions likely to be encountered during routine transport without any deterioration in the integrity of the package as a whole.



CAUTIONS AND WARNINGS



Upper Rear of Unit (Identification of Interconnect)

- ◆ Connector for 12 V dc input from the ac adapter.



Upper Side of Unit (Identification of Interconnect)

- ◆ 9-pin serial interface, used to download test data to a computer or serial printer.



Inside the Unit (Battery Holder)

- ◆ Carefully note the polarity of the two AA batteries when installing them in the battery holder. A battery may explode or leak if installed improperly.
- ◆ Do not dispose of batteries in a fire. A battery may explode if exposed to excessive heat.

SAFETY WARNINGS

The CoreReader is a safe, durable unit. Troxler cannot anticipate every example of improper or unauthorized use of this unit that may lead to malfunction or accident. If a particular use is *not specifically mentioned* in this manual as authorized, then assume that the use is unauthorized and improper.

Always follow the safety warnings in this manual and the safety procedures of your laboratory/company. Troxler recommends the following safety precautions.

- ◆ The CoreReader is designed as a bench-top laboratory test instrument. Place the unit on a level, sturdy surface.
- ◆ The ambient temperature should be between 10 and 50 °C (50 and 122 °F), and the relative humidity should be less than 92%.
- ◆ Locate the CoreReader *no more than* 2.4 m (8 ft) feet from the required 120 V ac outlet. Ensure that the distance does not place stress on the ac adapter cables.
- ◆ Only personnel who are familiar with the proper operation of the CoreReader should operate the device.
- ◆ Only qualified personnel (Troxler service representatives) should perform service and maintenance on the CoreReader when disassembly is required.
- ◆ Always unplug the CoreReader before performing service or maintenance.
- ◆ Do not attempt to disassemble or remove the radioactive sources from this device.

CHAPTER 3

SETUP AND OPERATION

This chapter describes how to set up and operate the Troxler Model 3660 CoreReader.

CONTENTS

Keypad.....	3-2
Site Selection	3-4
Installation	3-5
Turning the CoreReader On.....	3-6
First Time Setup.....	3-7
Taking a Measurement.....	3-8

KEYPAD

Figure 3–1 shows the layout of the CoreReader keypad and display. Table 3–1 lists the functions for each key.

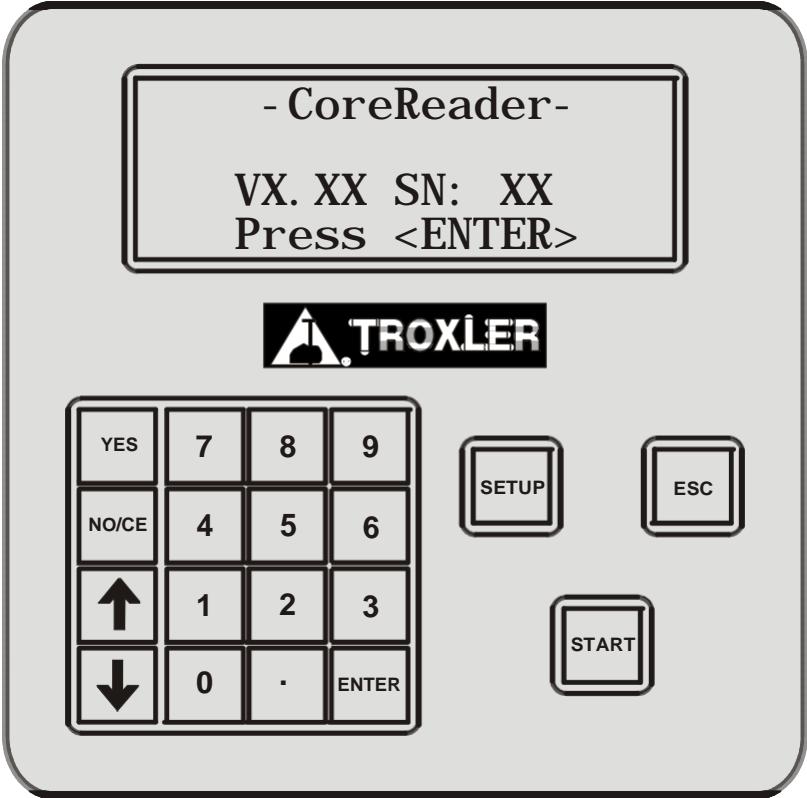

Figure 3–1. CoreReader Keypad and Display

Table 3–1. Keypad Functions

KEY	FUNCTION
⟨ SETUP ⟩	Press to access the CoreReader’s Setup menu.
⟨ ESC ⟩	Returns the CoreReader to the Ready screen without storing or updating data. When using the Setup menu or any of its submenus, pressing this key returns to the next higher-level menu.
⟨ START ⟩	Press to begin density measurements of an asphalt specimen.
⟨ YES ⟩	Press to respond <i>Yes</i> to <i>Yes/No</i> questions.
⟨ NO/CE ⟩	Press to respond <i>No</i> to <i>Yes/No</i> questions. Also clears an incorrect entry and allows for re-entry.
⟨↑⟩, ⟨↓⟩	Press to scroll through menu options or to view screens.
⟨ 0 ⟩ .. ⟨ 9 ⟩	Press to enter numeric values, or to access menu options.
⟨ . ⟩	Press to enter decimal point.
⟨ ENTER ⟩	Press after entering data.

SITE SELECTION

After unpacking and inspecting the CoreReader as described on page 1–4, select a suitable site for installation. Apply the following criteria when selecting a site:

- ◆ Ensure that there are no other nuclear sources in the vicinity of this equipment. An excess background radiation from a nearby source may affect the accuracy of the bulk specific gravity reading. The presence of another source may cause the standard count (see page 4–6) to be higher than usual or the bulk specific gravity reading for a known sample to be lower than expected.
- ◆ The CoreReader has no special ventilation or power requirements.
- ◆ Place the CoreReader on a level, sturdy work surface within 2.4 m (8 ft) feet of the required 120 V ac outlet. Ensure that the distance does not place stress on the ac adapter cables.
- ◆ The CoreReader must be placed at least 30 cm (1 ft) from any wall or other vertical surface.
- ◆ Do not place other objects, such as asphalt “pucks” or standard calibration cylinders, within 30 cm (1 ft) of the CoreReader.

INSTALLATION

The CoreReader requires no operator assembly. To begin using the CoreReader, follow the steps below:

- ✓ Following the site selection guidelines on the previous page set the CoreReader in place.
- ✓ Connect the ac adapter to the CoreReader, and then plug the adapter into a 120 V ac outlet.

NOTE

Troxler recommends using a surge protector or uninterruptible power supply on the ac power supplied to the CoreReader.

TURNING THE COREREADER ON

To begin using the Model 3660 CoreReader, turn the front panel power switch on. The CoreReader displays the following startup screen, which shows the software version (*V*) and serial number (*SN*) of the unit:

```
- CoreReader-  
VX. XX SN: XX  
Press <ENTER>
```

To continue, press **<ENTER>**. The CoreReader performs a self-test and warmup, then displays the following **Ready** screen:

```
- Ready-  
mm/dd/yyyy hh:mm PM  
Proj: (none)  
Press <START>
```

The **Ready** screen shows the current date (*mm/dd/yyyy*) and time (*hh:mm*) stored in the unit, as well as the name of the current project (*Prj.*).

NOTE

To ensure the stable operation of the CoreReader, Troxler recommends that the power switch be left on, even when the unit is not in use.

FIRST TIME SETUP

Before using the CoreReader for the first time:

1. Take a new set of standard counts as described on page 4–6.
2. Perform a calibration confirmation as described on page 5–9.
 - ▶ If the confirmation passes, the CoreReader can be used to take a measurement.
 - ▶ If the confirmation fails, perform a complete calibration as described on page 5–2 before taking measurements.

NOTE

The CoreReader is calibrated at the factory and is shipped with a set of *generic calibration constants* stored in its memory. Before taking measurements with the CoreReader, the user must confirm the calibration and re-calibrate the unit if necessary.

TAKING A MEASUREMENT

NOTE

The CoreReader's control software includes a number of options that can be configured by the operator for greater flexibility of operation. These options are accessed from the **Setup** menu described in Chapter 4. Before using the CoreReader for the first time, review Chapter 4 and configure the unit options as desired.

NOTE

Before measuring a pavement core, ensure that the specimen is free of foreign materials, such as soils, foundation materials, tack coat, and so on. Saw-cut irregular faces to ensure the two flat faces are parallel.

To take a measurement:

1. Using vernier calipers, determine the average height of the specimen (in millimeters) as follows:
 - ▶ For a specimen prepared using a gyratory compactor or Marshall hammer, measure the height in *four* evenly spaced locations and calculate the average height.
 - ▶ For a pavement core, saw-cut the bottom surface to form a flat face that is parallel to the top surface. If both surfaces are irregular, saw-cut them both to form two flat, parallel surfaces. The angle between the two faces should be less than 3°.

As show in Figure 3–2, mark *six* evenly spaced measurement locations on the surface of the core. Measure the specimen height at these six locations and calculate the average height.
2. Open the CoreReader door and slide the sample tray out. Place the specimen on the tray, return the tray to its home position, and close the door.
3. From the **Ready** screen shown on page 3–6, press **(START)**.

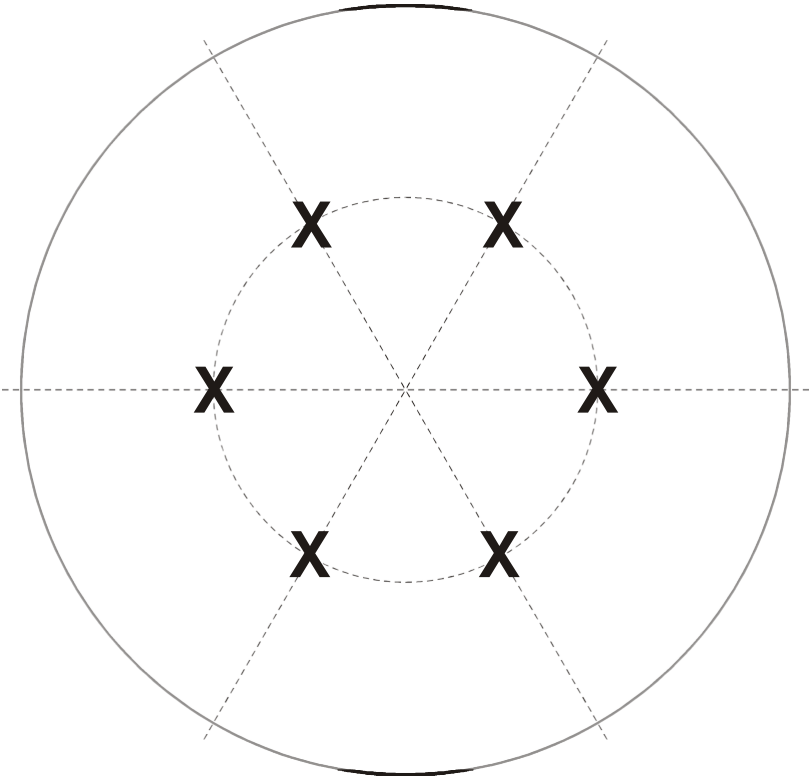

NOTE: Measure core height at locations marked with "X".

Figure 3–2. Measuring Height of a Core Sample

4. If *Prompt* mode is disabled (see the *Sample Type* section on page 4–5), proceed to step 5. If *Prompt* mode is enabled, the CoreReader requests the type of sample to be measured:

```

  - Sample Type-
  <1>150 mm LAB
  <2>150 mm FIELD
  <3>100 mm
  
```

Press <1>, <2>, or <3> to select the desired sample diameter and type.

NOTE

When taking a measurement on a 150-mm laboratory sample, the sample height must be 110 – 120 mm.

5. The CoreReader requests the average sample height determined in step 1:

Input Sample
Height
----- mm
Press <ENTER>

Using the numeric keypad, enter the average sample height and press <ENTER>.

6. The CoreReader asks whether the operator would like to enter the maximum specific gravity (Gmm):

Enter Max Specific
Gravity Gmm?

<YES> or <NO>

- ▶ To enter a Gmm value, press <YES> and proceed to step 7.
 - ▶ To continue without entering a Gmm value, press <NO/CE> and skip to step 8.
7. If <YES> is pressed in step 6, the CoreReader requests the Gmm value:

Input Gmm:

Press <ENTER>

Enter a value for Gmm and press <ENTER>.

- The CoreReader displays the information. Confirm that the height displayed is correct, and that the proper sample type and diameter are selected.

```
Ht-   xxx. x mm
Typ-  150 mm LAB
Gmm-  x. xxx
      Press <START>
```

NOTE

If **<NO/CE>** was pressed in step 6, the third line of the display is blank.

- ▶ If the information displayed is correct, press **<START>** to continue.
 - ▶ If the sample type or diameter is incorrect, press **<ESC>** to return to the **Ready** screen. Press **<SETUP>** and refer to page 4–5 for instructions on selecting the sample type and diameter.
- The CoreReader performs an initialization, during which it displays:

```
- CoreReader-
      I n i t i a l i z a t i o n
      P l e a s e   W a i t
```

- Following its initialization, the CoreReader starts a 4-minute measurement. During this time, the unit displays:

```
- CoreReader-
      M e a s u r e m e n t   i n
      P r o g r e s s   . . .
```

11. Upon completion, the CoreReader displays the measurement results:

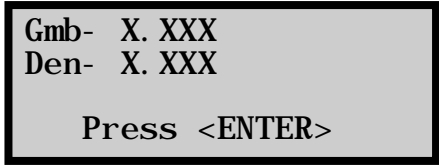

Press <ENTER> to return to the **Ready** screen. If the *Auto-Store* function (see page 4–13) is turned on, the CoreReader stores the measurement results under the active project.

12. Open the CoreReader door, slide the sample tray out, and remove the specimen from on the tray. Return the tray to its home position and close the door.

CHAPTER 4

SETUP MENU

The CoreReader control software includes a number of options that can be configured by the operator for greater flexibility of operation. These options are accessed from the **Setup** menu, its submenus, and displays. This chapter describes the many menu options

CONTENTS

Setup Menu	4-3
Gauge Status	4-4
Sample Type	4-5
Standard	4-6
Take New Count	4-6
View Counts	4-7
Erase Standard Bank	4-8
Clock/Calendar	4-9
Change Time	4-9
Change Date	4-10
Time Format	4-10
Date Format	4-11
Projects	4-12
Auto-Store	4-13
Manual Store	4-16
Select	4-19
Create	4-20
View	4-21
Erase	4-22
Output Project	4-23

CONTENTS (Continued)

Calibration 4-24

Confirmation 4-24

PC Output 4-25

Beeper 4-26



SETUP MENU

The CoreReader features a number of options that can be defined by the operator for greater flexibility of operation. To access these options, press **<SETUP>**. The CoreReader displays the **Setup** menu shown below. To select an item from the menu, press the corresponding numeric key. Use the up and down arrows to scroll through the menu options.

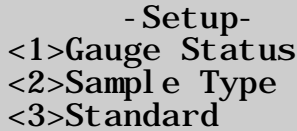

- Setup-
<1>Gauge Status
<2>Sample Type
<3>Standard

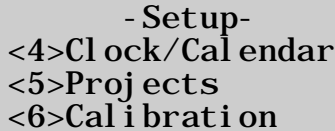

- Setup-
<4>Clock/Calendar
<5>Projects
<6>Calibration

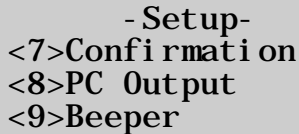

- Setup-
<7>Confirmation
<8>PC Output
<9>Beeper

For most of these items, pressing the corresponding numeric key displays a submenu. Many of these submenus in turn have submenus of their own.

GAUGE STATUS

The *Gauge Status* function enables the operator to view information concerning the CoreReader and its current setup. To view this information, press <1> on the **Setup** menu. The CoreReader displays:

```
Avg. Stnd: XXX
Last Stnd: XXX
      Date: mm/dd/yy
SPL. Type: 150 LAB
```

```
PC Output: OFF
Auto Store: OFF
Last RRVa: XX.X
Last RCVa: XX.X
```

Use the arrow keys to scroll between the displays.

The top three lines of the first display show the average of the last four *standard counts* (see page 4–6), the value of the most recent standard count, and the date the last standard count was taken.

The last line of the first display shows the currently selected *sample type* (in this example, the CoreReader is set up to measure 150-mm lab samples). To change the sample type, refer to page 4–5.

The second display shows the date that the status of the *PC Output* (see page 4–25) and *Auto-Store* (see page 4–13) functions.

NOTE

The *RRVa* and *RCVa* values are intended for Troxler factory use only.

Press <ESC> to return to the **Setup** menu.

SAMPLE TYPE

The CoreReader can accommodate both lab and field asphalt samples (cores) with diameters of 150 or 100 mm. To select the sample type and diameter, press <2> at the **Setup** menu shown on page 4-3. The CoreReader displays:

```
- Sample Type-  
<1>150 mm LAB  
<2>150 mm FIELD  
<3>100 mm
```

```
- Sample Type-  
<4>Prompt
```

Use the arrow keys to scroll through the menu options. Use the numeric keys to select a sample size and diameter, or press <4> to enable *Prompt* mode. In *Prompt* mode, the CoreReader prompts the user for the sample type before each measurement.

NOTE

When taking a measurement on a 150-mm laboratory sample, the sample height must be 110 – 120 mm.

Press <ESC> to return to the **Setup** menu.

STANDARD

The CoreReader uses a cesium-137 (Cs-137) gamma source to take density measurements. This low-level radioactive source undergoes a natural decay process that results in a gradual loss of strength. The time required for the source strength to diminish by 50% is referred to as the *half-life*. The half-life of Cs-137 is approximately 30 years.

To compensate for the source decay, a reference *standard count* is performed. Troxler recommends taking a standard count each day the CoreReader is to be used to ensure the highest accuracy and precision possible.

NOTE

Troxler recommends that the operator keep a daily log of the standard count (see Appendix C).

To access the **Standard** menu, press <3> from the **Setup** menu shown on page 4-3. The CoreReader displays:



- Standard-
<1>Take New Count
<2>View Counts
<3>Erase Stnd Bank

TAKE NEW COUNT

To take a new standard count, press <1> at the **Standard** menu. The CoreReader displays:

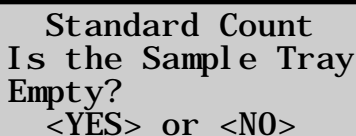

Standard Count
Is the Sample Tray
Empty?
<YES> or <NO>

Ensure that the sample tray is empty, and press **<YES>**. The CoreReader begins a 4-minute standard count. During the count, the unit displays:

- CoreReader -
Standard Count
in Progress. . .

Upon completion, if the standard count meets the predefined criteria, the CoreReader stores the new value and returns to the **Standard** menu.

If the standard count does not meet the predefined criteria, the CoreReader displays:

Error Code# 19
Please Refer
to Users Manual
Press <ENTER>

This error code (see Table A-1 on page A-2) indicates a high background count. Ensure that there are no other nuclear sources in the vicinity of the CoreReader and run a new standard count.

VIEW COUNTS

To view the result of the last standard count, press **<2>** at the **Standard** menu. The CoreReader displays the four most-recent standard counts, as well as the average of the four counts:

AVG Stnd: XXXX
1: XXXX 2: XXXX
3: XXXX 4: XXXX
<ESC> To Exit

Press **<ESC>** to return to the **Standard** menu.

ERASE STANDARD BANK

To erase the standard counts stored in the CoreReader memory, press **<3>** at the **Standard** menu. The CoreReader displays:

Erase Standard
Storage Bank?
<YES> or **<NO>**

Press **<YES>** to erase the standard counts stored in memory, or **<NO/CE>** to return to the **Standard** menu without erasing the counts.

CLOCK/CALENDAR

The CoreReader is shipped with the current date and time (Eastern Standard Time) stored in its memory. By default, the CoreReader displays the date in *mm/dd/yyyy* format (where *mm* = month, *dd* = day, and *yyyy* = year) and the time in *AM/PM* format. To change the date, time, or display format, press <4> at the **Setup** menu shown on page 4–3. The CoreReader displays the **Clock/Calendar** menu shown below. Use the arrow keys to scroll through the menu options. Press <ESC> to return to the **Setup** menu.

```
- Cl ock/Cal endar-  
<1>Change Ti me  
<2>Change Date  
<3>Ti me Format
```

```
- Cl ock/Cal endar-  
<4>Date Format
```

CHANGE TIME

To set the current time, press <1> at the **Clock/Calendar** menu. The CoreReader displays:

```
  hh: mm AM  
Arrows toggle AM/PM  
Input Time and  
Press <ENTER>
```

(Note that in this example, the time is displayed in *AM/PM* format. To change the format, see the *Time Format* section on page 4–10.) To accept the displayed time, press <ENTER>. To change the time, use the numeric keys to enter the new time, and the arrow keys to toggle between *AM* and *PM*. Press <ENTER>. The CoreReader sets the time and returns to the **Clock/Calendar** menu.

CHANGE DATE

To set the current date, press **<2>** at the **Clock/Calendar** menu. The CoreReader displays:

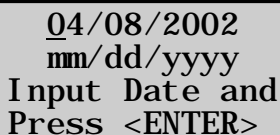
A screenshot of the CoreReader's date input screen. The text is centered and reads: "04/08/2002" with the "04" underlined, "mm/dd/yyyy" below it, "Input Date and" below that, and "Press <ENTER>" at the bottom.

04/08/2002
mm/dd/yyyy
Input Date and
Press <ENTER>

(Note that in this example, the time is displayed in *mm/dd/yyyy* format. To change the date format, refer to the *Date Format* section on page 4–11.) To accept the displayed date, press **<ENTER>**. To change the date, use the numeric keys to enter the new date. When finished, press **<ENTER>**. The CoreReader sets the date and returns to the **Clock/Calendar** menu.

TIME FORMAT

The CoreReader can display the time in either *AM/PM* or *24-hour* format. To select the desired time format, press **<3>** at the **Clock/Calendar** menu. The CoreReader displays:

A screenshot of the CoreReader's time format selection screen. The text is centered and reads: "- Time Format -", "<1>AM/PM", and "<2>24- Hour".

- Time Format -
<1>AM/PM
<2>24- Hour

Use the numeric keys to select the desired format, and press **<ENTER>**. The CoreReader sets the time format and returns to the **Clock/Calendar** menu.

DATE FORMAT

The CoreReader can display the date in either *mm/dd/yyyy* or *dd/mm/yyyy* format, where *mm* = month, *dd* = day, and *yyyy* = year. To select the desired date format, press **<4>** at the **Clock/Calendar** menu. The CoreReader displays:

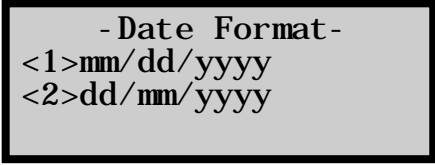

```
- Date Format -  
<1>mm/dd/yyyy  
<2>dd/mm/yyyy
```

Use the numeric keys to select the desired format, and press **<ENTER>**. The CoreReader sets the date format and returns to the **Clock/Calendar** menu.

PROJECTS

The CoreReader stores sample data in *project files* under *project IDs* defined by the operator. Up to 20 project IDs can be defined. When a project is *active*, all measurements are stored in memory under the active project ID. The stored sample data includes the sample number, date and time of the measurement, sample type and diameter, and the measured specific gravity and density values for the sample. Stored data can be retrieved, printed, and downloaded.

The **Projects** menu allows the operator to select (activate) an existing project; to create and activate a new project; to view stored project data; and to erase, print, or download a project. To access these options, press **<5>** at the **Setup** menu shown on page 4–3. The CoreReader displays:

```
- Projects-  
<1>Auto Store  
<2>Manual Store  
<3>Select
```

```
- Projects-  
<4>Create  
<5>View  
<6>Erase
```

```
- Projects-  
<7>Output Project
```

Use the arrow keys to scroll through the menu options. Use the numeric keys to select a menu option. Press **<ESC>** to return to the **Setup** menu.

AUTO-STORE

The *Auto-Store* function automatically stores sample data upon completion of a measurement. The data is stored under the active project, using a sequential auto-sample ID number. When a new project is created, the sample ID number for the *Auto-Store* function starts at 1 and is incremented each time a new measurement is stored automatically.

NOTE

The *Auto-Store* sample ID number is *not* incremented when sample data is stored manually (see page 4–15). When using the *Manual Store* function, the sample ID number is entered manually. Therefore, it is possible to inadvertently store duplicate sample ID numbers under an active project.

For example, assume that the *Auto-Store* function is disabled and the operator manually stores sample data from two measurements using sample IDs 1 and 2. If the *Auto-Store* function is then enabled, the data for the next two measurements will also be stored as sample IDs 1 and 2.

To prevent duplication of sample ID numbers, Troxler recommends either using sample IDs beginning at 100 or higher when storing sample data manually or always enabling the *Auto-Store* function.

To access the *Auto-Store* function, press <1> at the **Projects** menu. The CoreReader displays:



```
Auto-Store
<1> ON
<2> OFF
```

- ▶ To return to the **Projects** menu without changing the *Auto-Store* status, press **⟨ESC⟩**.
- ▶ To turn the *Auto-Store* function on, press **⟨1⟩**.
- ▶ To turn the *Auto-Store* function off, press **⟨2⟩**. The CoreReader updates the *Auto-Store* status, displays a brief confirmation message, and returns to the **Projects** menu.

Active Project Selected

If the operator attempts to enable the *Auto-Store* function and a project has been selected as active, the CoreReader enables the *Auto-Store* function, briefly displays the confirmation message shown below, and then returns to the **Projects** menu.

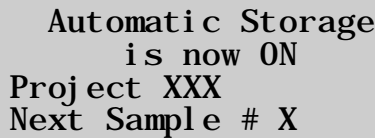

Automatic Storage
is now ON
Project XXX
Next Sample # X

No Project Data

If the operator attempts to enable the *Auto-Store* function but no project has been created, the CoreReader displays:

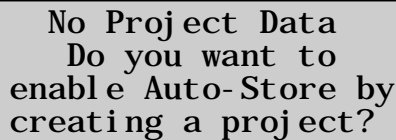

No Project Data
Do you want to
enable Auto-Store by
creating a project?

- ▶ To return to the **Projects** menu without enabling the *Auto-Store* function, press **⟨NO/CE⟩**.
- ▶ To create a project and enable the *Auto-Store* function, press **⟨YES⟩**. The CoreReader displays the screens required to create a project as described on page 4–20. When the project ID is complete, the CoreReader sets the project as active, displays the confirmation message shown above, and returns to the **Projects** menu.

No Project Selected

If the operator attempts to enable the *Auto-Store* function and one or more projects have been created but no project has been selected as active, the CoreReader displays:

**Auto-Store Requires
An Active Project:
<1> Select Project
<2> Create Project**

- ▶ To select an existing project, press <1>. The CoreReader displays the screens required to select a project as described on page 4–18. After the project is selected, the CoreReader sets the project as active, briefly displays the confirmation shown on page 4–14, and returns to the **Projects** menu.
- ▶ To create a new project ID, press <2>.
 - ▶ If twenty project IDs have already been defined, the CoreReader displays an error message.
 - ▶ If fewer than twenty projects have been defined, the CoreReader displays the screens required to create a project as described on page 4–20. After the project ID is created, the CoreReader sets the project as active, briefly displays the confirmation shown on page 4–14, and then returns to the **Projects** menu.

MANUAL STORE

After completing a measurement and before taking another one, sample data can be stored manually under the active project ID. (See page 4–20 for details on creating a project ID.) To access the *Manual Store* function, press **(2)** at the **Projects** menu.

If there is no sample data to be stored, the CoreReader displays an error message and returns to the previous display.

NOTE

The *Auto-Store* sample ID number is *not* incremented when sample data is stored manually. When using the *Manual Store* function, the sample ID number is entered manually. Therefore, it is possible to inadvertently store duplicate sample ID numbers under an active project.

For example, assume that the *Auto-Store* function is disabled and the operator manually stores sample data from two measurements using sample IDs 1 and 2. If the *Auto-Store* function is then enabled, the data for the next two measurements will also be stored as sample IDs 1 and 2.

To prevent duplication of sample ID numbers, Troxler recommends either using sample IDs beginning at 100 or higher when storing sample data manually or always enabling the *Auto-Store* function.

ACTIVE PROJECT SELECTED

If the operator initiates the *Manual Store* function, there is sample data to be stored, *and* a project has been selected as active, the CoreReader displays:

Input New Sample
Number —

Press <ENTER>

Enter a sample number (up to six numerals). Troxler recommends that manually stored samples be numbered beginning at *100* or higher. When the sample number is complete, press **⟨ENTER⟩**.

If there is sufficient memory, the CoreReader stores the sample data under the active project ID and sample number entered, briefly displays a confirmation message, then returns to the **Projects** menu.

If there is insufficient memory to store the data, the CoreReader displays an error message and returns to the previous screen. One or more projects must be deleted before the new project data can be stored.

No Project Data

If the operator initiates the *Manual Store* function and there is sample data to be stored, but no project IDs have been created, the CoreReader displays:



No Project Data
Do You Want To
Create a Project?

- ▶ To return to the **Projects** menu without creating a project or storing the sample data, press **⟨NO/CE⟩** or **⟨ESC⟩**.
- ▶ To create a project, press **⟨YES⟩**. The CoreReader displays the screens required to create a project as described on page 4–20. When the project ID is complete, the CoreReader sets the project as active, displays a brief confirmation message, then requests the sample number as described in the *Active Project Selected* section on page 4–16.

No Project Selected

If the operator initiates the *Manual Store* function and there is sample data to be stored, but there is no active project (although project IDs have been created), the CoreReader displays:

Specify a Project To
Store To:
<1> Select Project
<2> Create Project

- ▶ To return to the **Projects** menu without selecting a project or storing the sample data, press <ESC>.
- ▶ To create a new project, press <2>. The CoreReader displays the screens required to create a project as described on page 4–20. When the project ID is complete, the CoreReader sets the project as active, displays a brief confirmation message, then requests the sample number as described in the *Active Project Selected* section on page 4–16.
- ▶ To select an existing project, press <1>. The CoreReader displays:

- Setup-
<1>Scroll Projects
<2>Enter Project ID

- ▶ To return to the **Projects** menu without selecting a project or storing the sample data, press <ESC>.
- ▶ To select a project, press <1> to scroll through the list of created projects, or <2> to enter a known project ID. For more information on selecting a project, refer to page 4–18. After a project ID has been selected, the CoreReader sets the project as active, briefly displays a confirmation message, then requests the sample number as described in the *Active Project Selected* section on page 4–16.

SELECT

The *Select* function allows the operator to activate an existing project. To select an existing project, press **<3>** at the **Projects** menu shown on page 4–12. The CoreReader displays:

- Setup-
<1>Scroll Projects
<2>Enter Project ID

- ▶ To scroll through the stored projects, press **<1>**. The CoreReader displays the first project ID. Use the arrow keys to scroll through the list of projects, then press **<ENTER>** when the desired project ID is displayed. The CoreReader sets the selected project as active, briefly displays a confirmation message, and returns to the **Projects** menu.
- ▶ To enter a *known* project ID, press **<2>** at the **Select** display. The CoreReader displays:

-
To Scroll Chars
<YES> to Select Char
<ENTER> When Done

Enter a project ID using up to twelve alphanumeric characters. Use the numeric keys to enter numbers and move the cursor to the next position. To enter alphabetic characters, use the arrow keys to scroll through the characters. When the desired character is displayed, press **<YES>** to move the cursor to the next position. To move the cursor back one position, press the **<NO/CE>** key.

NOTE

After the last character has been entered, press **<YES>** to accept the character before pressing **<ENTER>** to accept the project ID.

When the project ID is complete, press **<ENTER>**. If the project ID entered is not valid, the CoreReader displays **Requested Project not found** and returns to the **Projects** menu. If the project ID entered is valid, the CoreReader sets the project as active, displays a brief confirmation message, and returns to the **Projects** menu.

CREATE

To create and activate a new project, press **<4>** at the **Projects** menu shown on page 4–12. The CoreReader displays:

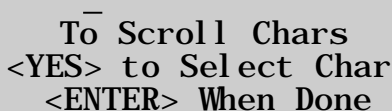

To Scroll Chars
<YES> to Select Char
<ENTER> When Done

Enter a project ID using up to twelve alphanumeric characters. Use the numeric keys to enter numbers and move the cursor to the next position. To enter alphabetic characters, use the arrow keys to scroll through the characters. When the desired character is displayed, press **<YES>** to move the cursor to the next position. To move the cursor back one position, press the **<NO/CE>** key.

NOTE

After the last character has been entered, press **<YES> to accept the character before pressing **<ENTER>** to accept the project ID.**

When the project ID is complete, press **<ENTER>**. The CoreReader sets the entered project ID as active, briefly displays a confirmation message, and returns to the **Projects** menu.

VIEW

To view the sample data for a selected project, press **<5>** at the **Projects** menu shown on page 4–12. The CoreReader displays:

```
View
<1>Scroll Projects
<2>Enter Project ID
```

Press **<1>** to scroll through the stored projects, or **<2>** to enter a *known* project ID. Follow the same procedures as described in the *Select* section on page 4–19 to select or enter the desired project ID.

If the selected project contains no sample data, the CoreReader displays the message **No Samples Found in Selected Project** and returns to the **Projects** menu.

If the selected project contains sample data, the CoreReader displays the data for the first sample. Two screens of data are shown for each sample, as follows:

```
Sample #X
MM/DD/YYYY  HH: MM AM
Gmb:      xxx
Height:  xxx. x mm
```

```
Sample #X
Type: FIELD
Diameter: 150 mm
Gmm: XXX
```

Use the arrow keys to scroll through the sample data. When finished, press **<ESC>** to return to the **Projects** menu.

ERASE

The *Erase* function allows the operator to erase a selected project or all projects. To access the *Erase* function, press **<6>** at the **Projects** menu. The CoreReader displays:

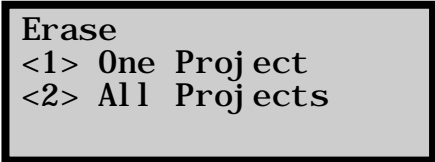

Erase
<1> One Project
<2> All Projects

To erase all project files, press **<2>** and follow the prompts. To erase a single project file, press **<1>**. The CoreReader displays:



- Setup -
<1> Scroll Projects
<2> Enter Project ID

Press **<1>** to scroll through the stored projects, or **<2>** to enter a *known* project ID. Follow the same procedures as described in the *Select* section on page 4–19 to select or enter the ID of the project to be erased.

The CoreReader displays:

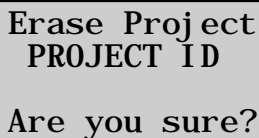

Erase Project
PROJECT ID

Are you sure?

- ▶ To erase the displayed project, press **<YES>**. The CoreReader erases the project, displays a brief confirmation message, and returns to the **Projects** menu.
- ▶ To return to the **Projects** menu without erasing the project, press **<NO/CE>** or **<ESC>**.

OUTPUT PROJECT

The *Output Project* function is used to download measurement data stored in the CoreReader to a computer or other serial device.

NOTE

To ensure proper data transfer, the cable connected to the serial communications port should not exceed 3 m (10 ft) in length.

To output project data, press **<7>** at the **Projects** menu. The CoreReader displays:



Output
<1> One Project
<2> All Projects

- ▶ To output data from a single project, press **<1>**. The CoreReader displays:



- Setup -
<1> Scroll Projects
<2> Enter Project ID

Press **<1>** to scroll through the stored projects, or **<2>** to enter a *known* project ID. Follow the same procedures as described in the *Select* section on page 4–19 to select or enter the desired project ID.

- ▶ To output the data from all projects, press **<2>**.

After the operator has selected the desired project(s) to be output, the CoreReader displays:

```
- Output Format -  
<1>Formatted  
<2>Comma Delimited
```

Press **<1>** to select the *Formatted* output or **<2>** to output data in *Comma Delimited* format. The CoreReader outputs the data for the selected project(s) and returns to the **Projects** menu.

CALIBRATION

The *Calibration* function is described in Chapter 5.

CONFIRMATION

The *Confirmation* function is described in Chapter 5.

PC OUTPUT

The CoreReader can automatically output measurement data to a personal computer (PC) or serial printer. To enable or disable the PC output, press **<8>** on the **Setup** menu. The CoreReader displays:

```
- PC Output -  
<1> ON  
<2> OFF  
Press # To Select
```

Press **<1>** to turn the PC output on or **<2>** to turn it off. The CoreReader sets the function to the desired state, displays a brief confirmation message, and returns to the **Setup** menu.

BEEPER

The CoreReader is equipped with an external beeper mounted on its rear panel. The external beeper can be enabled or disabled as desired. To control the external beeper, press **<9>** on the **Setup** menu. The CoreReader displays:

- External Beeper -
<1> ON
<2> OFF
Press # to Select

Press **<1>** to enable the external beeper or **<2>** to disable it. The CoreReader sets the external beeper function to the desired state, displays a brief confirmation message, and returns to the **Setup** menu.

CHAPTER 5

CALIBRATION AND CONFIRMATION

This chapter provides information and procedures for calibrating and confirming operating parameters for the Model 3660 CoreReader.

CONTENTS

Calibration	5-2
New Calibration	5-3
View Constants	5-8
Remote Calibration	5-8
Confirmation.....	5-9
150 mm Lab Confirmation.....	5-10
150 mm Field Confirmation.....	5-12
100 mm Confirmation.....	5-13

CALIBRATION

The CoreReader is calibrated at the factory and is shipped with a set of *generic calibration constants* stored in its memory. Before taking measurements with the CoreReader, the user must confirm the calibration and re-calibrate the unit if necessary. During calibration, a new set of *calibration constants*, which the CoreReader uses to calculate test results, are calculated and stored in memory.

NOTE

The CoreReader must be calibrated in the location in which it will be used.

Eight calibration standard cylinders (see Figure 5–1) are provided with the CoreReader for use in calibrating the equipment. These cylinders have a known density; diameters of 150 mm (6 in.) and 100 mm (4 in.); and heights of 12.7 mm (0.5 in.), 25.4 mm (1.0 in.), 50.8 mm (2.0 in.), and 88.9 mm (3.5 in.).

NOTE

The CoreReader should be calibrated if a part is replaced, a mechanical change has occurred, or the unit is moved to a new location.

If the unit is moved, Troxler recommends performing a confirmation (see page 5–9) with the CoreReader in the new location. If the confirmation mode fails in any mode, re-calibrate that mode.

A complete CoreReader calibration includes three calibration *modes*. The first mode calibrates the CoreReader for taking measurements on 150-mm (6-in.) diameter *laboratory* specimens with heights from 110.0 mm (4.33 in.) to 120.0 mm (4.72 in.). The second mode calibrates the CoreReader for measuring 150-mm diameter *field* specimens with heights from 22.0 mm (0.87 in.) to 178.0 mm (7.0 in.). The third and final calibration mode calibrates the CoreReader for measuring 100-mm (4-in.) diameter specimens with heights from 22.0 mm (0.87 in.) to 178.0 mm (7.0 in.).

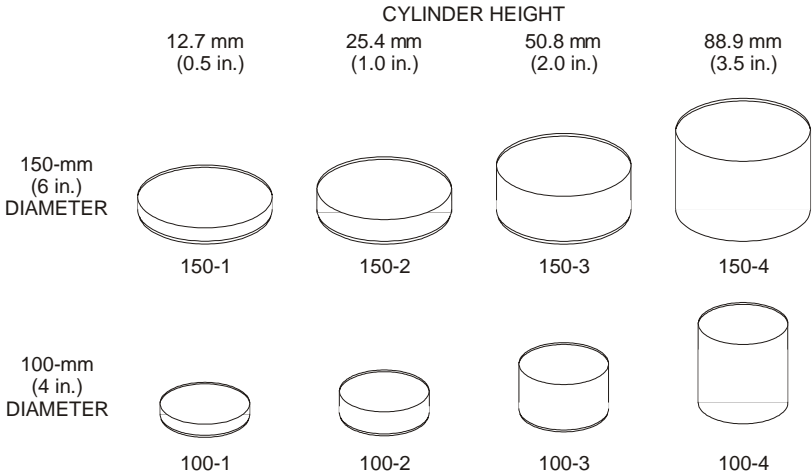

Figure 5–1. Calibration Standard Cylinders

To access the **Calibration** menu, press **<6>** at the **Setup** menu shown on page 4–3. The CoreReader requests an *access code*:

Input Access Code

—

Press **<ENTER>**

Use the number keys to enter the access code (see page xi) and press **<ENTER>**.

After the access code is entered, the CoreReader displays the **Calibration** menu:

- Calibration-
<1>New Calibration
<2>View Constants
<3>Remote Calib

Use the numeric keys to select a menu option. Press **<ESC>** to return to the **Setup** menu.

NEW CALIBRATION

To calibrate the CoreReader, press <1> at the **Calibration** menu shown on page 5-3. The CoreReader displays:

```
- New Calibration-  
<1>150 mm LAB  
<2>150 mm FIELD  
<3>100 mm
```

Use the numeric keys to select a calibration mode. Press <ESC> to return to the **Setup** menu.

NOTE

A full calibration requires the completion of all three calibration modes.

NOTE

After the CoreReader has been calibrated, Troxler recommends performing a calibration confirmation as described on page 5-9.

NOTE

After successful completion of a calibration and confirmation, Troxler recommends that the user record the calibration constants in the *Calibration Constants Log* provided in Appendix C.

150 mm Lab Calibration

During a 150-mm lab calibration, the CoreReader takes measurements on three configurations of the 150-mm diameter calibration standard cylinders shown in Table 5–1. For each configuration, the CoreReader takes a series of six measurements, with each series lasting a total of approximately 40 minutes.

To calibrate the CoreReader for 150-mm diameter laboratory specimens, press **<1>** at the **New Calibration** menu shown on page 5–3. The CoreReader displays:

Place Cylinder
XXXXX
on Tray and
Press <START>

Where XXXXX is one of the cylinder configurations shown in Table 5–1. Place the requested cylinder(s) into the CoreReader and press **<START>**. The CoreReader takes six calibration measurements, during which it displays the following status message:

- CoreReader-
150 mm LAB
Calibration
Count X/6

*Table 5–1. Cylinder Configurations,
150-mm Lab Calibration*

CoreReader Prompt	Cylinder Configuration
150-4	150-4 only
150-1->150-4	150-1 stacked on 150-4
150-2->150-4	150-2 stacked on 150-4

Upon completion of the six measurements (approximately 40 minutes), the CoreReader requests the next cylinder configuration. Place the requested cylinder(s) into the CoreReader and press **<START>**. Repeat until all cylinder configurations have been measured.

After completing calibration measurements on the three cylinder configurations, the CoreReader software computes the new calibration constants, stores the constants in memory, and displays **Calibration Complete**. Press **<ENTER>** to return to the **New Calibration** menu shown on page 5–3.

150 mm Field Calibration

The 150-mm field calibration is similar to the one described in the *150 mm Lab Calibration* section on page 5–4, except that during this calibration, the CoreReader takes measurements on *six* configurations of the 150-mm diameter calibration standard cylinders as shown in Table 5–2. For each configuration, the CoreReader takes a series of six measurements, with each series lasting a total of approximately 30 minutes.

To calibrate the CoreReader for 150-mm diameter laboratory specimens, press **<2>** at the **New Calibration** menu shown on page 5–3. Follow the display prompts to take measurements on each cylinder configuration in Table 5–2.

*Table 5–2. Cylinder Configurations,
150-mm Field Calibration*

CoreReader Prompt	Cylinder Configuration
150-2	150-2 only
150-3	150-3 only
150-2->150-3	150-2 stacked on 150-3
150-1->150-4	150-1 stacked on 150-4
150-3->150-4	150-3 stacked on 150-4
150-2->150-3->150-4	150-2 stacked on 150-3 and 150-4

After completing calibration measurements on the six cylinder configurations, the CoreReader software computes the new calibration constants, stores the constants in memory, and displays **Calibration Complete**. Press **<ENTER>** to return to the **New Calibration** menu shown on page 5-3.

100 mm Calibration

The 100-mm calibration is similar to the one described in the *150 mm Field Calibration* section on page 5-6, except that the CoreReader takes measurements using the 100-mm diameter calibration standard cylinders shown in Table 5-3. For each cylinder configuration, the CoreReader takes a series of six measurements, with each series lasting a total of approximately 30 minutes.

To calibrate the CoreReader for 100-mm diameter specimens, press **<3>** at the **New Calibration** menu shown on page 5-3. Follow the display prompts to take measurements on each cylinder configuration in Table 5-3.

After completing calibration measurements on the six cylinder configurations, the CoreReader software computes the new calibration constants, stores the constants in memory, and displays **Calibration Complete**. Press **<ENTER>** to return to the **New Calibration** menu shown on page 5-3.

Table 5-3. Cylinder Configurations, 100-mm Calibration

CoreReader Prompt	Cylinder Configuration
100-2	100-2 only
100-3	100-3 only
100-2->100-3	100-2 stacked on 100-3
100-1->100-4	100-1 stacked on 100-4
100-3->100-4	100-3 stacked on 100-4
100-2->100-3->100-4	100-2 stacked on 100-3 and 100-4

VIEW CONSTANTS

The *View Constants* function enables the operator to view the calibration constants that the CoreReader uses to calculate test results.

To access the *View Constants* function, press **<1>** at the **Calibration** menu shown on page 5–3. The CoreReader displays:

```
- Sample Diameter -  
<1>150 mm  
<2>100 mm  
Press # To Select
```

Press **<1>** to view the constants used to calculate test results for 150-mm diameter specimens or press **<2>** to view the constants used for 100-mm specimens. The CoreReader displays five screens of values for a 150-mm diameter specimen or four screens for a 100-mm specimen. Use the arrow keys to scroll between the screens. Press **<ESC>** to return to the **Calibration** menu.

REMOTE CALIBRATION

The *Remote Calibration* selection is intended for Troxler factory use only.

CONFIRMATION

The *Confirmation* function is used to confirm the accuracy of the CoreReader calibration using the calibration standard cylinders provided with the unit (see Figure 5–1 on page 5–3). These cylinders have diameters of 150 mm (6 in.) and 100 mm (4 in.) and heights of 12.7 mm (0.5 in.), 25.4 mm (1.0 in.), 50.8 mm (2.0 in.), and 88.9 mm (3.5 in.).

As described in the *Calibration* section on page 5–1, a complete CoreReader calibration includes three calibration *modes*: a 150-mm *lab* calibration, a 150-mm *field* calibration, and a 100-mm calibration. Similarly, a complete calibration confirmation includes running the confirmation function in these same three modes, but involves fewer cylinder configurations and CoreReader measurements than a calibration. A full confirmation involves performing a total of eight confirmation measurements as described in the following sections. If any of the confirmation measurements fail, the CoreReader should be recalibrated as described in the *Calibration* section on page 5–1.

NOTE

To ensure the accuracy of CoreReader measurements, Troxler recommends performing a calibration confirmation on a regular basis.

To perform a calibration confirmation, press <7> at the **Setup** menu shown on page 4–3. The CoreReader displays:

```
- Confir mation-  
<1>150 mm LAB  
<2>150 mm FIELD  
<3>100 mm
```

Use the numeric keys to select a menu option. Press <ESC> to return to the **Setup** menu.

150 MM LAB CONFIRMATION

During a 150-mm lab confirmation, the CoreReader takes measurements on the two configurations of the 150-mm diameter calibration standard cylinders shown in Table 5–4. The measurement on each cylinder configuration lasts approximately eight minutes.

To confirm the CoreReader’s calibration for 150-mm diameter laboratory specimens, press <1> at the **Confirmation** menu on page 5–9. The CoreReader displays:

Place Cylinder
XXXXX
on Tray and
Press <START>

Where XXXXX is one of the cylinder configurations shown in Table 5–4. Place the requested cylinder(s) into the CoreReader and press <START>. The CoreReader takes a confirmation measurement, during which it displays the following status message:

- CoreReader-
150 mm LAB
Calibration
Count X/2

*Table 5–4. Cylinder Configurations,
150-mm Lab Confirmation*

CoreReader Prompt	Cylinder Configuration
150-4	150-4 only
150-2->150-4	150-2 stacked on 150-4

After each measurement (approximately eight minutes), the CoreReader displays:

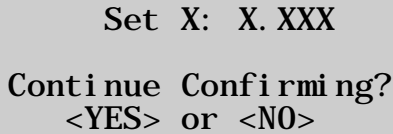

Set X: X. XXX
Continue Confirming?
<YES> or <NO>

Refer to Table 5–5 on page 5–12 to determine if the displayed value is within the acceptance limits.

- ▶ If the displayed value is within the limits, the confirmation passes. Press **<YES>** to continue with the confirmation.
- ▶ If the displayed value is outside of the limits, press **<NO/CE>** to return to the **Confirmation** menu, and repeat the confirmation using the cylinder(s) currently in the CoreReader.
- ▶ If the displayed value is the limits tolerance on the second measurement, the confirmation passes. Press **<YES>** to continue with the confirmation.
- ▶ If the displayed value is outside of the limits on the second measurement, the CoreReader should be recalibrated as described starting on page 5–3. Press **<NO/CE>** to return to the **Confirmation** menu.

After completing confirmation measurements on the two cylinder configurations, the CoreReader displays:

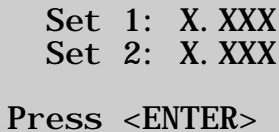

Set 1: X. XXX
Set 2: X. XXX
Press <ENTER>

Press **<ENTER>** to return to the **Confirmation** menu on page 5–9.

Table 5–5. Confirmation Acceptance Limits

Confirmation Mode	CoreReader Prompt	Cylinder Height (mm)	Min	Max
150-mm Lab	150-4	88.9	2.706	2.726
	150-2, 150-4	101.6	2.706	2.726
150-mm Field	150-2	25.4	2.700	2.740
	150-2, 150-3	76.2	2.706	2.730
	150-2, 150-3, 150-4	165.1	2.690	2.730
100-mm	100-2	25.4	2.700	2.740
	100-2, 100-3	76.2	2.706	2.730
	100-2, 100-3, 100-4	165.1	2.690	2.730

150 MM FIELD CONFIRMATION

The 150-mm field confirmation is similar to the one described in the *150 mm Lab Confirmation* section on page 5–9, except that during this confirmation, the CoreReader takes measurements on *three* configurations of the 150-mm diameter calibration standard cylinders as shown in Table 5–6. Each measurements lasts approximately eight minutes.

To confirm the CoreReader’s calibration for 150-mm diameter field specimens, press **(2)** at the **Confirmation** menu on page 5–9. Follow the display prompts to take measurements on each cylinder configuration in Table 5–6.

Table 5–6. Cylinder Configurations,
150-mm Field Confirmation

CoreReader Prompt	Cylinder Configuration
150-2	150-2 only
150-2->150-3	150-2 stacked on 150-3
150-2->150-3->150-4	150-2 stacked on 150-3 and 150-4

After each measurement (approximately eight minutes), the CoreReader displays:

Set X: X. XXX
Continue Confirming?
<YES> or <NO>

Refer to Table 5–5 on page 5–12 to determine if the displayed value is within the acceptance limits.

- ▶ If the displayed value is within the limits, the confirmation passes. Press <YES> to continue with the confirmation.
- ▶ If the displayed value is outside of the limits, press <NO/CE> to return to the **Confirmation** menu, and repeat the confirmation using the cylinder(s) currently in the CoreReader.
- ▶ If the displayed value is the limits tolerance on the second measurement, the confirmation passes. Press <YES> to continue with the confirmation.
- ▶ If the displayed value is outside of the limits on the second measurement, the CoreReader should be recalibrated as described starting on page 5–3. Press <NO/CE> to return to the **Confirmation** menu.

After completing confirmation measurements on the three cylinder configurations, the CoreReader displays:

Set 1: X. XXX
Set 2: X. XXX
Set 3: X. XXX
Press <ENTER>

Press <ENTER> to return to the **Confirmation** menu on page 5–9.

100 MM CONFIRMATION

The 100-mm confirmation is similar to the one described in the *150 mm Field Confirmation* section on page 5–12, except that the CoreReader takes measurements using the 100-mm diameter calibration standard cylinders shown in Table 5–7. Each measurement lasts approximately 8 minutes.

To confirm the CoreReader’s calibration for 100-mm diameter specimens, press **(3)** at the **Confirmation** menu on page 5–9. Follow the display prompts to take measurements on each cylinder configuration in Table 5–7.

After each measurement (approximately eight minutes), the CoreReader displays:

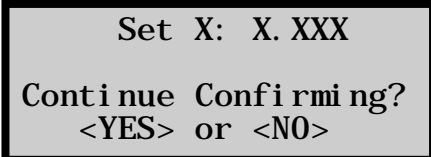

Set X: X.XXX
Continue Confirming?
<YES> or <NO>

Refer to Table 5–5 on page 5–12 to determine if the displayed value is within the acceptance limits.

- ▶ If the displayed value is within the limits, the confirmation passes. Press **(YES)** to continue with the confirmation.
- ▶ If the displayed value is outside of the limits, press **(NO/CE)** to return to the **Confirmation** menu, and repeat the confirmation using the cylinder(s) currently in the CoreReader.
- ▶ If the displayed value is the limits tolerance on the second measurement, the confirmation passes. Press **(YES)** to continue with the confirmation.
- ▶ If the displayed value is outside of the limits on the second measurement, the CoreReader should be recalibrated as described starting on page 5–3. Press **(NO/CE)** to return to the **Confirmation** menu.

Table 5–7. Cylinder Configurations, 100-mm Confirmation

CoreReader Prompt	Cylinder Configuration
100-2	100-2 only
100-2->100-3	100-2 stacked on 100-3
100-2->100-3->100-4	100-2 stacked on 100-3 and 100-4

After completing confirmation measurements on the three cylinder configurations, the CoreReader displays:

```
Set 1: X. XXX
Set 2: X. XXX
Set 3: X. XXX
Press <ENTER>
```

Press **(ENTER)** to return to the **Confirmation** menu on page 5–9.

NOTES

APPENDIX A

TROUBLESHOOTING AND SERVICE

This appendix contains information on servicing and maintaining the Model 3660 CoreReader.

CONTENTS

Troubleshooting.....	A-2
General Maintenance	A-3
Replacing Parts	A-4
Replacing the Batteries.....	A-4
Replacing the Front Panel Assembly.....	A-5
Replacement Parts.....	A-6
Accessories.....	A-6
Returning Parts for Service.....	A-7
Troxler Service Centers	A-8

TROUBLESHOOTING

COREREADER DOES NOT TURN ON

- ✓ Check that the power switch is in the *ON* position.
- ✓ Ensure that the ac adapter is plugged in.
- ✓ Check the power to the wall outlet.
- ✓ Check that the fuse for the wall outlet is not blown or that the circuit breaker is not tripped.

COREREADER FAILS STANDARD COUNTS

- ✓ Check that any sources are at least 33 ft (10 m) away.
- ✓ Take another standard count. If the standard count still fails, contact the nearest Troxler Service Center (see page A-8).

COREREADER DISPLAYS AN ERROR CODE

- ✓ Refer to Table A-1. If more information is needed, contact the nearest Troxler Service Center (see page A-8).

ALL OTHER ERROR MESSAGES

- ✓ Record the error message.
- ✓ Contact the nearest Troxler Service Center (see page A-8) for further information.

Table A-1. Error Codes

Error Code	Description
05	Density value is outside of acceptable limits.
07	Calibration constants are outside of acceptable limits.
13	System was unable to initialize.
15	Sample height is out of range.
19	Results indicate a high background count.
31	Calculation error.
37	Calibration attempted with NO standard counts.

GENERAL MAINTENANCE

This section provides general service information for the CoreReader, including instructions for cleaning the unit.

CAUTION

Do not use a degreasing cleaner or glass cleaner to clean the clear chamber door. To prevent damage to the door surface, use a mild detergent only.

NOTE

Use any degreasing cleaner and a clean rag to clean metal parts.

- ✓ Clean the tabletop, sample tray, and external surfaces with a degreasing cleaner.
- ✓ Wipe or scrape away any asphalt residue that has adhered to the sample tray.
- ✓ Vacuum the entire tabletop and sample tray areas.
- ✓ After cleaning the tabletop, wipe the areas with a clean, dry cloth.

REPLACING PARTS

The following sections provide instructions for replacing the CoreReader batteries and front panel assembly.

REPLACING THE BATTERIES

The CoreReader uses two AA batteries to maintain the stored data and real-time clock. The unit monitors the battery voltage. If the battery voltage is low, the CoreReader displays a “low battery” symbol on the default screen. To avoid memory loss, replace the batteries at least once a year.

WARNING

Carefully note the polarity of the batteries when installing them in the battery holder. A battery may explode or leak if installed improperly.

The battery holder is located inside the CoreReader. To replace the batteries:

1. Turn the power switch off and disconnect the ac adapter from the back panel connector.
2. Remove the six Phillips-head screws that secure the back panel.
3. Remove the back panel and set it aside.
4. Locate the battery holder and note the polarity of the AA batteries.
5. Remove the old batteries and install new AA batteries.
6. Install the back panel using the screws removed in step 2.
7. Reconnect the ac adapter and turn the power switch on.

REPLACING THE FRONT PANEL ASSEMBLY

To replace the CoreReader front panel assembly:

1. Turn the power switch off and disconnect the ac adapter from the back panel connector.
2. Using an Allen-wrench, remove the four screws that secure that overlay bezel assembly. Remove the bezel assembly and set it aside.
3. Using the Allen wrench, remove the four screws that secure the front panel assembly.
4. Carefully lift the old front panel assembly from the CoreReader.
5. Carefully note the location and polarity (if applicable) of each cable connected to the front panel assembly. Disconnect each cable.
6. Connect each cable removed in the previous step to the new front panel assembly.
7. Install the new front panel assembly using the screws removed in step 2.
8. Install the bezel assembly using the screws removed in step 1.
9. Perform a complete calibration and confirmation as described in Chapter 5.

CAUTION

To ensure proper operation of the CoreReader, a complete calibration and confirmation must be performed after the front panel assembly has been replaced. Refer to Chapter 5 for calibration and confirmation instructions.

REPLACEMENT PARTS

<u>PART #</u>	<u>DESCRIPTION</u>
109815	Front panel assembly

ACCESSORIES

<u>PART #</u>	<u>DESCRIPTION</u>
108534	AC adapter, 12 V dc, CE international
106514	Cable assembly, serial, 8 ft
109707	Model 3660 CoreReader <i>Manual of Operation and Instruction</i>

RETURNING PARTS FOR SERVICE

Items returned for service must be accompanied by an RGA (Returned Goods Authorization) number, and a description of the instrument and its problem. This information is used by Troxler shipping and service personnel to expedite the repair work.

To obtain an RGA number, please call or fax Troxler headquarters at Research Triangle Park, or one of the branch offices with your request.

Please have the following information available when requesting an RGA number:

- Unit (or part) model and serial number.
- Part number/serial number (if applicable).
- Is the unit (part) still under warranty?
- Problem or difficulty you are having with the unit.
- Shipment method to Troxler and for return shipment.
- Shipping and billing address (not P.O. Box) – street address and zip.
- Phone number/contact (for questions from Troxler).
- Will estimate be required prior to performing any work on the part?
- Payment method: credit card, account number, or purchase order number. **All government agencies (city, county, state, and federal) must send purchase order numbers.**

NOTE

To prevent order duplication, if an order has been placed by telephone, please write “Confirming Order” on any follow-up written requests.

TROXLER SERVICE CENTERS

Troxler Corporate Headquarters

3008 Cornwallis Road
P.O. Box 12057
Research Triangle Park, NC 27709
Tel (919) 549-8661
Fax (919) 549-0761
E-mail: troxserv@troxlerlabs.com
Web: www.troxlerlabs.com

Maryland Service Center

9574 Deereco Road
Timonium, MD 21093
Tel (410) 561-5850
Fax (410) 561-5852
E-mail: troxlermd@troxlerlabs.com

Midwestern Branch Office

1430 Brook Drive
Downers Grove, IL 60515
Tel (630) 261-9304
Fax (630) 261-9341
E-mail: troxmidw@troxlerlabs.com

Western Regional Branch Office

11300 Sanders Drive, Suite 7
Rancho Cordova, CA 95742
Tel (916) 631-0234
Fax (916) 631-0541
E-mail: troxca@troxlerlabs.com

Southwestern Branch Office

2000 East Randol Mill Road
Suite 611
Arlington, TX 76011
Tel (817) 275-0571
Fax (817) 275-8562
E-mail: troxsw@troxlerlabs.com

Florida Service Center

2376 Forsyth Road
Orlando, FL 32807
Tel (407) 681-4221
Fax (407) 681-3188
E-mail: troxlerfl@troxlerlabs.com

Colorado Service Center

702 West 48th Avenue, Unit G
Denver, CO 80216
Tel: (303) 298-0751
Fax: (303) 298-0778
E-mail: troxlerco@troxlerlabs.com

Canadian Branch Office

7125 Pacific Circle, Unit 13
Mississauga, Ontario L5T-2A5
Canada
Tel (905) 565-0633
Fax (905) 564-7092
E-mail: troxler@istar.ca

Troxler European Subsidiary

Troxler Electronics GmbH
Gilchinger Strasse 33
D-82239 Alling nr. Munich, Germany
Tel ++49-8141-71063
Fax ++49-8141-80731
E-mail: troxler@t-online.de

APPENDIX B

SPECIFICATIONS

This appendix provides environmental conditions and specifications for the Model 3660 CoreReader.

CONTENTS

Measurement Specifications	B-2
Environmental Conditions	B-3
Electrical Specifications	B-4
Mechanical Specifications	B-5

MEASUREMENT SPECIFICATIONS

Sample Geometry	Cylindrical samples with parallel flat faces. Samples produced using a gyratory compactor or Marshall Hammer method meets this geometry. For field samples obtained from coring, saw-cut the bottom to form a flat face that is parallel to the top face.
Sample Diameter	100 mm (4 in.) and 150 mm (6 in.)
Sample Height	22.0 to 175.0 mm (0.87 to 6.89 in.)
Tolerance of Cylinder Height	For a field sample, the height should be determined from the average of six evenly spaced height measurements with a precision of 0.1 mm at sigma level.
Count Time	See Table B-1.
Precision of Bulk Specific Gravity at 1-Sigma Level	See Table B-1.

Table B-1. CoreReader Precision and Count Times

Sample Type	Height (mm)	Precision of Bulk Specific Gravity at 1-Sigma Level	Count Time (min)
150-mm Lab	110 to 120	0.004 @ Gmb = 2.400	4
150-mm Field	Less than 50	0.006 @ Gmb = 2.400 and height = 35.0mm	8
150-mm Field	Equal to or greater than 50	0.004 @ Gmb = 2.400 and height = 75.0mm	4
100-mm	Less than 50	0.006 @ Gmb = 2.400 and height = 35.0mm	8
100-mm	Equal to or greater than 50	0.004 @ Gmb = 2.400 and height = 75.0mm	4

ENVIRONMENTAL CONDITIONS

Use	Indoor
Ambient Storage Temperature	-55 to 85 °C (-67 to 185 °F)
Ambient Operating Temperature	5 to 40 °C (41 to 104 °F)
Altitude Rating	2000 m maximum
Main Supply Voltage Fluctuation	± 10%
Pollution Degree	2
Installation Category (Overvoltage Category)	II
Humidity	80% for temperatures up to 31 °C, decreasing linearly to 50% relative humidity at 40 °C

ELECTRICAL SPECIFICATIONS

Power Requirements:

**Power supply
(AC adapter)** 100–240 V ac, 47–63 Hz,
Single phase, 0.4 A

CoreReader 12 V dc, 500 mA

Serial Port:

Connector 9-pin male D-subminiature connector
RS-232 standard

Data format 8 data bits, 1 stop bit, no parity

Baud rate 9600

Cable type RS-232 null modem

9-pin female – 9 (25) pin female

MECHANICAL SPECIFICATIONS

Size 30.8 W × 41.2 D × 73.8 H cm
(12.2 W × 16.2 D × 29.0 H in)

Weight 35 kg (77 lb)

Shipping Weight

CoreReader with accessories 44.5 kg (98 lb)

Calibration standard cylinders 11.3 kg (25 lb)

NOTES

APPENDIX C

LOG FORMS

Use the forms in this appendix as a guide when recording the daily standard counts. To verify gauge stability, compare the daily standard count to the average of the last four recorded standard counts.

CONTENTS

Standard Count Logs	C-2
Calibration Constants Logs.....	C-8

STANDARD COUNT LOGS

STANDARD COUNT LOG

CoreReader Serial Number _____

Date	Average	Location	Comments



STANDARD COUNT LOG

CoreReader Serial Number _____

Date	Average	Location	Comments

C. LOG FORMS

STANDARD COUNT LOG

CoreReader Serial Number _____

Date	Average	Location	Comments

STANDARD COUNT LOG

CoreReader Serial Number _____

Date	Average	Location	Comments

C. LOG FORMS

STANDARD COUNT LOG

CoreReader Serial Number _____

Date	Average	Location	Comments

STANDARD COUNT LOG

CoreReader Serial Number _____

Date	Average	Location	Comments

C. LOG FORMS

CALIBRATION CONSTANTS LOGS

CALIBRATION CONSTANTS LOG (SHEET 1)

CoreReader Serial Number _____

150-mm LAB	Date				
	Std Count				
	A				
	B				
	Litho				
150-mm	Date				
	Std Count				
	A1				
	B1				
	C1				
	A2				
	B2				
	C2				
	A3				
	B3				
	C3				
	H1				
	H2				
	H3				

CALIBRATION CONSTANTS LOG (SHEET 2)

100-	Date				
	Std Count				
	A1				
	B1				
	C1				
	A2				
	B2				
	C2				
	A3				
	B3				
	C3				
	H1				
	H2				
	H3				

CALIBRATION CONSTANTS LOG (SHEET 1)

CoreReader Serial Number _____

150-mm LAB	Date				
	Std Count				
	A				
	B				
	Litho				
150- mm	Date				
	Std Count				
	A1				
	B1				
	C1				
	A2				
	B2				
	C2				
	A3				
	B3				
	C3				
	H1				
	H2				
	H3				

CALIBRATION CONSTANTS LOG (SHEET 2)

100-	Date				
	Std Count				
	A1				
	B1				
	C1				
	A2				
	B2				
	C2				
	A3				
	B3				
	C3				
	H1				
	H2				
	H3				

CALIBRATION CONSTANTS LOG (SHEET 1)

CoreReader Serial Number _____

150-mm LAB	Date				
	Std Count				
	A				
	B				
	Litho				
150- mm	Date				
	Std Count				
	A1				
	B1				
	C1				
	A2				
	B2				
	C2				
	A3				
	B3				
	C3				
	H1				
	H2				
	H3				

CALIBRATION CONSTANTS LOG (SHEET 2)

100-	Date				
	Std Count				
	A1				
	B1				
	C1				
	A2				
	B2				
	C2				
	A3				
	B3				
	C3				
	H1				
	H2				
	H3				

CALIBRATION CONSTANTS LOG (SHEET 1)

CoreReader Serial Number _____

150-mm LAB	Date				
	Std Count				
	A				
	B				
	Litho				
150- mm	Date				
	Std Count				
	A1				
	B1				
	C1				
	A2				
	B2				
	C2				
	A3				
	B3				
	C3				
	H1				
	H2				
	H3				

CALIBRATION CONSTANTS LOG (SHEET 2)

100-	Date				
	Std Count				
	A1				
	B1				
	C1				
	A2				
	B2				
	C2				
	A3				
	B3				
	C3				
	H1				
	H2				
	H3				

NOTES

INDEX

1

100-mm	
Calibration	5-7
Confirmation.....	5-14
150-mm	
Field calibration	5-6
Field confirmation.....	5-12
Lab calibration	5-5
Lab confirmation.....	5-10

A

Access code	xi
Accessories	A-6
Air eligibility (transportation).....	2-5
Altitude rating.....	B-3
Ambient temperature	B-3
Auto-Store.....	4-13

B

Batteries, replacing	A-4
Baud rate.....	B-4
Beeper, external	4-26

C

Calibration	5-2
100-mm.....	5-7
150-mm field	5-6
150-mm lab	5-5
Constants.....	5-2
Constants log.....	C-8
New.....	5-4
Remote.....	5-8
Standard cylinders.....	5-3
Cesium-137.....	2-2
Half-life.....	4-6
Clock/Calendar menu	4-9

Confirmation	5-9
100-mm	5-14
150-mm field	5-12
150-mm lab.....	5-10
Count time	B-2
Create project	4-20

D

Date	4-10
Format	4-11
Disposal	2-4

E

Electrical specifications.....	B-4
Environmental conditions.....	B-3
Erase	
Project.....	4-22
Standard bank	4-8
Error	
Codes	A-2
Messages	A-2

F

Fluctuation, supply voltage	B-3
Front panel assembly, replacing	A-5

G

Gauge status	4-4
--------------------	-----

H

Humidity.....	B-3
---------------	-----

I

ID number	
Project.....	4-12
Sample.....	4-13
Inspecting	1-4
Installation	
Categories.....	B-3
CoreReader.....	3-5

K

Keypad..... 3-2

L

Low battery A-4

M

Maintenance schedule..... A-3

Manual Store..... 4-16

Marking, package 2-5

Measurement specifications..... B-2

Mechanical specifications..... B-5

Menu

Clock/Calendar 4-9

Projects 4-12

Setup 4-3

N

New calibration..... 5-4

O

Operating temperature B-3

Output

PC 4-25

Project..... 4-23

P

Packaging requirements 2-6

Parts A-6

Returning A-7

PC output 4-25

Power requirements B-4

Precision B-2

Project	
Create	4-20
Erase	4-22
Files	4-12
Identification (ID) number	4-12
Menu.....	4-12
Output.....	4-23
Select	4-19
View	4-21

R

Radiological information.....	2-2
Remote calibration	5-8
Replacement parts	A-6
Returning parts	A-7

S

Safety information	2-1
Sample	
Diameter	4-5, B-2
Geometry	B-2
Height	B-2
Identification (ID) number	4-13
Type.....	4-5
Select	
Project.....	4-19
Serial port	B-4
Service centers.....	A-8
Setup	
First time	3-7
Menu.....	4-3
Site selection.....	3-4
Size	B-5
Specifications	B-1
Electrical.....	B-4
Measurements.....	B-2
Mechanical	B-5

Standard count	4-6
Log	C-2
New	4-6
View	4-7
Storage temperature	B-3
Store	
Auto	4-13
Manual	4-16
Supply voltage fluctuation	B-3

T

Temperature	
Operating	B-3
Storage	B-3
Time	4-9
Format	4-10
Transportation	2-5
Troubleshooting	A-2

U

Unpacking	1-4
-----------------	-----

V

View	
Constants	5-8
Project	4-21
Standard count	4-7

W

Waybill	2-6
Weight	B-5

NOTES

NOTES

WARRANTY

TROXLER ELECTRONIC LABORATORIES, INC.

LIMITED WARRANTY

TROXLER ELECTRONIC LABORATORIES, INC., and subsidiary, TROXLER INTERNATIONAL, LTD., hereinafter referred to as "TROXLER," warrants this instrument, Model 3660 CoreReader, Serial Number _____, against defects in material and workmanship for a period of twelve (12) months from date of shipment. For gauges sold through authorized TROXLER representatives, the date of shipment will be as of the transfer from representative to purchaser. During the applicable warranty period, TROXLER's obligation under this warranty shall be limited exclusively to the repair at no charge, except for shipping to and from TROXLER'S plant, of any instrument which may prove defective under normal use and which TROXLER's examination shall disclose to its satisfaction to be thus defective. Normal use is defined for the purpose of this warranty as operation under normal load, usage, and conditions with proper care and maintenance and competent supervision. In no event shall TROXLER be held liable for damages, delays, or losses consequential, incidental, or otherwise attributable to the failure of this instrument or radioactive material contained therein. TROXLER's liability being specifically limited to repair as stated hereinabove. This warranty is automatically initiated except where modified by contractual or other written and signed agreement.

THERE ARE NO WARRANTIES WHICH EXTEND BEYOND THE DESCRIPTION ON THE FACE HEREOF, AND THIS WARRANTY IS EXPRESSLY IN LIEU OF ALL OTHER WARRANTIES, EXPRESSED OR IMPLIED, AND TROXLER NEITHER ASSUMES, NOR AUTHORIZES ANYONE TO ASSUME FOR IT ANY OTHER LIABILITY IN CONNECTION WITH THE SALE OF THE INSTRUMENT. THIS WARRANTY SHALL NOT APPLY TO THE INSTRUMENT OR ANY PART THEREOF, WHICH HAS BEEN SUBJECTED TO DAMAGE BY ACCIDENT, NEGLIGENCE, ALTERATION, ABUSE, MISUSE, OR SERVICE NOT AUTHORIZED IN WRITING BY TROXLER. SUCH DAMAGE TO INCLUDE BUT NOT BE LIMITED TO BURNING OF CIRCUIT BOARDS AND HARNESS FROM IMPROPER SOLDERING TECHNIQUES AND DAMAGE TO THE INSTRUMENT DUE TO PURCHASER'S FAILURE TO PERFORM MAINTENANCE AS OUTLINED IN THE AUTHORIZED OPERATOR'S MANUAL. DUE TO THE NATURE OF THEIR USE, MECHANICAL ACCESSORY PARTS AND BATTERIES ARE WARRANTED FOR 90 DAYS ONLY FROM DATE OF SHIPMENT.

TROXLER ELECTRONIC LABORATORIES, INC.

Troxler International, Ltd.
Troxler Electronics (Canada), Ltd.
3008 Cornwallis Road
Post Office Box 12057
Research Triangle Park, NC 27709 USA

NOTICE TO CONSUMERS

Any disclaimer or limitation on the remedies expressed above shall not be effective to the extent prohibited by state or federal law.

NOTE: THIS WARRANTY EXCLUDES DAMAGE INCURRED IN SHIPMENT. IF THIS INSTRUMENT IS RECEIVED IN DAMAGED CONDITION, THE CARRIER SHOULD BE CONTACTED IMMEDIATELY. ALL CLAIMS FOR DAMAGE IN TRANSIT SHOULD BE FILED WITH THE CARRIER. IF REQUESTED, TROXLER WILL AID IN FILING OF CLAIMS AND/OR LOCATING GAUGES LOST IN TRANSIT.